



Spray application and digital manufacturing automation systems



We are



We offer to our customer the world best technology systems in the field of Automated manufacturing Systems for Automotive and general Industries .

ROBOTIC
SYSTEMS

DIGITAL
AUTOMATION

SPRAY
APPLICATION

Why Us



Robspray approach –**"SMART"** way of work execution individual customers needs Since each customer has different way of operation methodology.

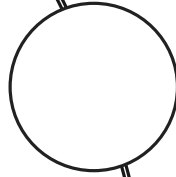

Robspray -Transfer **"KNOW-HOW"** to customers to develop their skills and become a part of customer team to enhanced productivity.

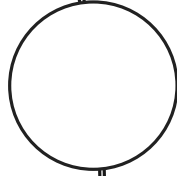

Robspray is working on different -2 Technology platform for same systems as per customer requirements to **"PASS-ON"** cost and quality benefited to customers and break the barrier for fixed out bound technology.

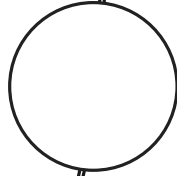

Robspray innovative solutions are filling the gap for customer choice apart from **OEM SUPPORT** and services for pre installed equipment's as well new project execution.

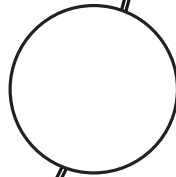

Robspray search and **ENABLING** customers to pay less for similar service and solutions which may and may not be available as per customer budget and specification.



Robspray team has great **EXPERIENCE** with safety, reliability and speed of execution.



**CAMERA VISION BASED
SYSTEM -TYPE
RECOGNITION AND LIVE
MONITORING**



**CONTROL PANEL
MANUFACTURING –MOTION
CONTROL AND POWER
DISTRIBUTION**



**PAINT PROCESS CONTROL
SYSTEMS-PAINT BOOTH
AUTOMATION**

Our Systems



**DIGITAL MANUFACTURING
SYSTEMS –INSTRUMENT
,PLC HMI & SCADA
CUSTOMIZED SOLUTION**



**ROBOTIC APPLICATION-
MATERIAL HANDLING AND
PAINT SPRAY ROBOT**



**MANUFACTURING
CONTROL SYSTEMS-
PROCESS DIAGNOSTIC AND
REPORTING**

Our Systems



ELECTRO- PNEUMATIC CONTROL SYSTEM-VALVE OPERATION AND INSTRUMENT CONTROL PANEL

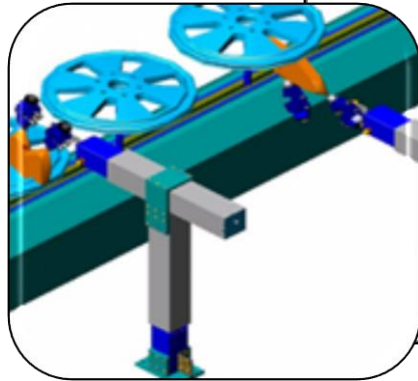

SPRAY PAINT MACHINE –WHEEL CAP,FRAME,LIGHTS,CYLINDER,DOOR AND WINDOW,DECORATIVE

Our Systems



AUTO CLEANING SYSTEMS -SPRAY JET CLEANING .CO₂ CLEANING

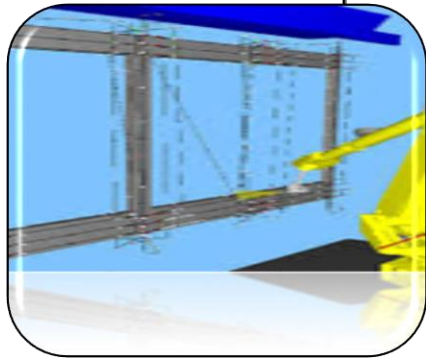

**SOFTWARE AND SIMULATION –
PAINT ROBOTIC CELL SETUP
AND 3D CAD MODLING
SYSTEMS**



**ERROR PROFFING SYSTEMS –
SENSOR BASED CLOSED LOOP
CONTROL INTERGARTION**

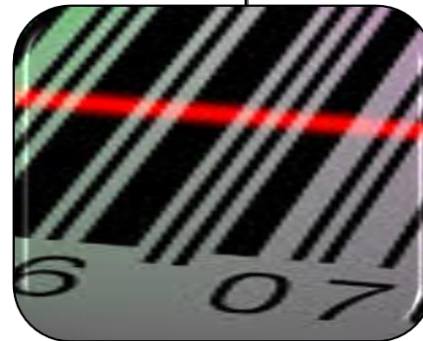

**PRODUCT TARCKING SYSTEMS
–BARCODE SCANNING AND
RFID CONTROL & MONITORING
STATIONS**

Our Systems

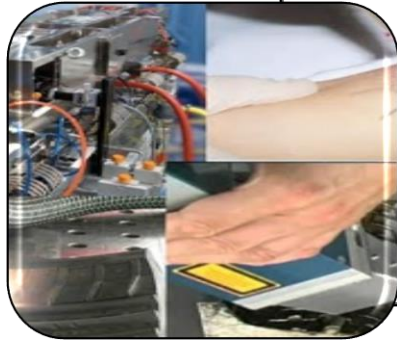

**ANNUAL MAINTENANCE
CONTRACT -ROBOTS AND
EQUIPMENT**



**PROCESS OPTMIZATION
PRODUCT LAUNCH PAINT
PARAMETER ADJUSTMENT**



**PROJECT RETROFITTING
AND RELOCATION –
EQUIPMENT AND ROBOTS**

Our services

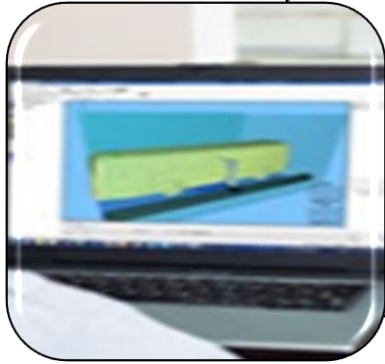

**ROBOT PROGRAMMING –
PAINT AND HANDLING
ROBOT FOR ALL BRAND**



**ENGINEERING DESIGN AND
DEVELOPMENT –CONTROL
CIRCUIT,LINE LAYOUT,RFO
PREPERATION,DRAWING**

Our services



**INSTALLATION AND
COMMISSIONING-ROBOTS
AND EQUIPMENTS**



**PROJECT MANAGEMENT AND
CONSULTANCY-**END TO END**
FOR PAINT LINE**

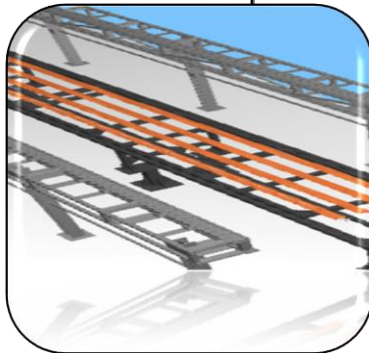

**TURNEKY SOLUTION-
ROBOTIC PAINT BOOTH AND
NEW PRODUCT LINE SETUP**



**TRAINING AND
DEVELOPMENT –**PAINT ROBOT**
,ATOMIZER PAINT PROCESS
SETUP PLC/HMI/SCADA**

Our services

For any query please contact us :

Robspray Technology Systems Private Limited

Registered Office : 4/65,Chiranjeev Vihar ,Ghaziabad (U.P.)-201002
E Mail : robspraysystems@gmail.com

Corporate Office: B-28,2nd Floor ,Sector-67,Noida (U.P.) -201301
Phone +91-9810-480-698,9810483698
E Mail : info@robspray.com

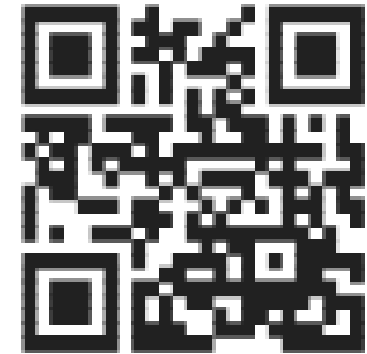

www.robspray.com